

Mechatronics and Instrumentation Servicing Management

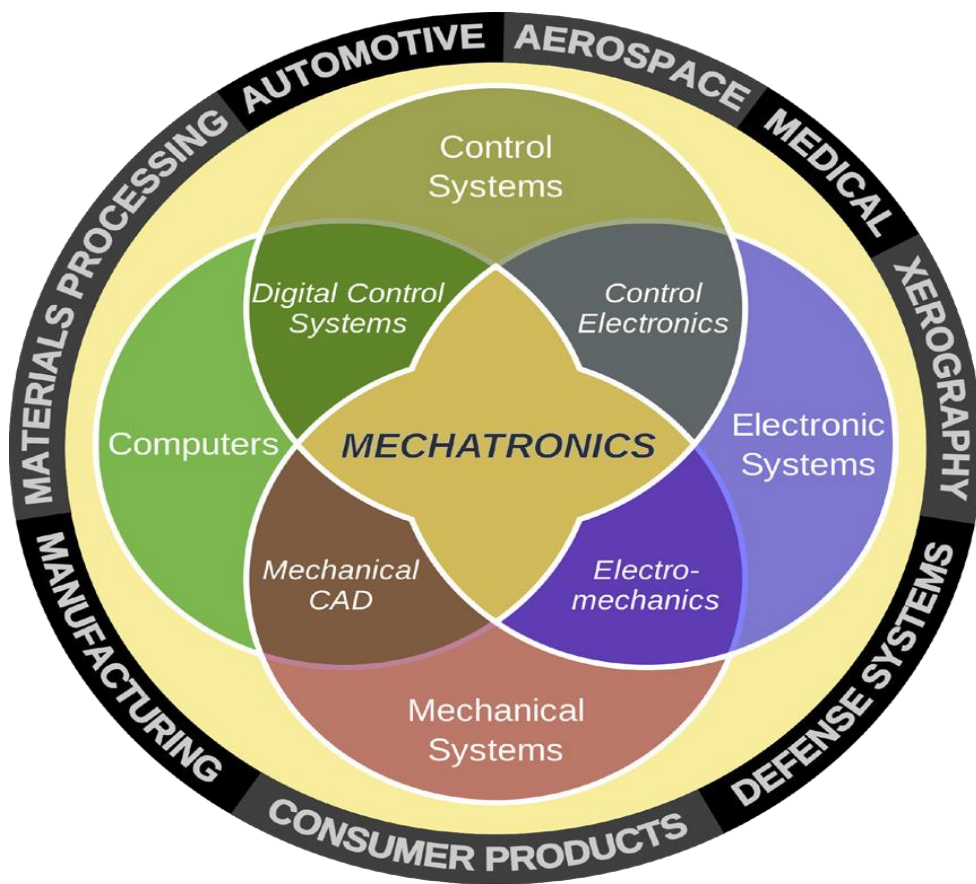

SAFETY

Personal safety

Concern for your own safety as well as the safety of others should always be on your mind. Most safety procedures are common sense but, because some hazards are not obvious, there are regulations born out of experience which are designed to make the workplace safer.

There are two aspects of safety which concern us in the assembly of electrical equipment and control panels. The first concerns your own personal safety.

In the words of the *Health and Safety Regulations*:

- + The need to use safe working practices and safety equipment to avoid the risk of injury to yourself and to others in the course of your work. While it is beyond the scope of this book to cover the detail of all the safety precautions and safe working practices which should be adopted, there are some general points which can be noted.
- + Safety equipment, e.g. goggles, gloves, etc., should be provided and *must be used* where they are appropriate.
- + The onus is on you to use the safety equipment provided by your company. Any damage to safety gear should be reported. Safe working practices are part of any job and you should always learn and adopt them as a natural way of working.
- + Don't take shortcuts which compromise your safety, or that of anybody else.
- + You should make yourself aware of the procedures used at your place of work to prevent accidents and to deal with common incidents.
- + You should know how to isolate electric supplies and how to work safely on electrical circuits.

Accidents

- + Know how to contact the correct person – *the designated first aider* – for help.
- + Find out the location of the nearest first aid box.
- + Know how to isolate electric supplies and how-to release a person safely from contact with electricity.

Fire

Before starting work on electric plant, you should know:

- + Where is the nearest fire alarm activator, fire exit and fire extinguisher?
- + Are the fire exits clear of equipment or rubbish?

Extinguishers for electrical fires

Be aware that *special extinguishers* are needed for fires which occur in *live electrical equipment*

- + Do not use water-based extinguishers.
- + RED extinguishers are water-based for wood/paper/cloth/plastic fires only.
- + GREEN extinguishers are halo or BCF-based for general fires (not gases) including electrical fires.
- + BLACK extinguishers are CO₂-based for flammable liquids and electrical fires

Electric shock

Learn the basic first aid action drill.

- + **DO NOT TOUCH** the victim with your bare hands until the power is off or they have been
- + Pulled away from contact otherwise you will get a shock as well.
- + Switch off the power and drag the victim off the live conductor.
- + Alternatively if you cannot switch off then use something *non-conducting* to move the victim away from contact. Dry wood, plastic tubing (PVC conduit) even a dry piece of cloth folded several times will do.

Part I

INTRODUCTION TO MECHATRONICS

What is Mechatronics?

- “The name [mechatronics] was invented by Ko Kikuchi, now president of Yasakawa Electric Co., Chiyoda-Ku, Tokyo.”
- “The word, mechatronics is composed of *mecha* from mechanics and *tronics* from electronics. In other words, technologies and developed products will be incorporating electronics more and more into mechanisms, intimately and organically, and making it impossible to tell where one ends and the other begins.”

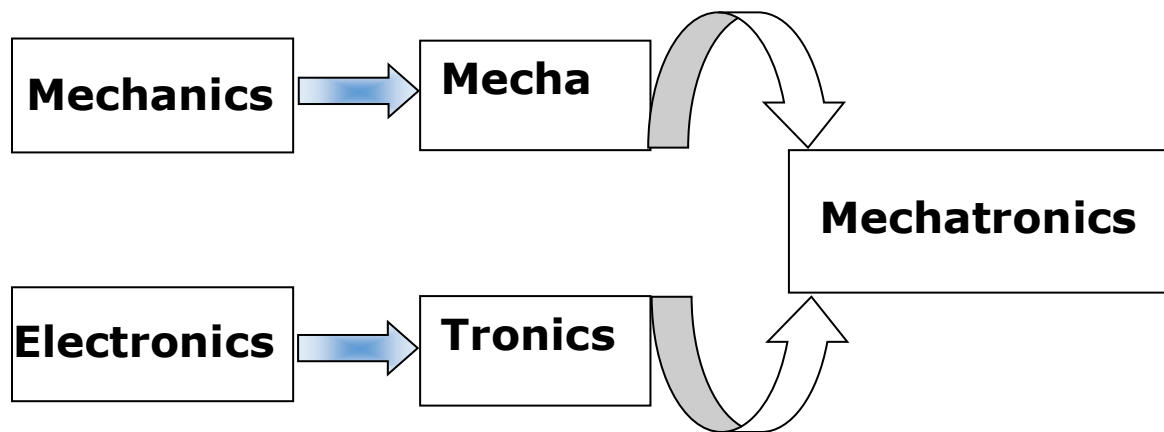

Some definition about mechatronics

1. “Integration of electronics, control engineering, and mechanical engineering.”
 - *W. Bolton, Mechatronics: Electronic Control Systems in Mechanical Engineering, Longman, 1995.*
2. “Application of complex decision making to the operation of physical systems.”
 - *D. M. Auslander and C. J. Kempf, Mechatronics: Mechanical System Interfacing, Prentice-Hall, 1996.*
3. “Synergistic integration of mechanical engineering with electronics and intelligent computer control in the design and manufacturing of industrial products and processes.”
 - *F. Harshama, M. Tomizuka, and T. Fukuda, “Mechatronics-what is it, why, and how?-and editorial,” IEEE/ASME Trans. on Mechatronics, 1(1), 1-4, 1996.*
4. “Synergistic use of precision engineering, control theory, computer science, and sensor and actuator technology to design improved products and processes.”
 - *S. Ashley, “Getting a hold on mechatronics,” Mechanical Engineering, 119(5), 1997.*
5. “Methodology used for the optimal design of electromechanical products.”
 - *D. Shetty and R. A Kolk, Mechatronics System Design, PWS Pub. Co., 1997.*
6. “Field of study involving the analysis, design, synthesis, and selection of systems that combine electronics and mechanical components with modern controls and microprocessors.”
 - *D. G. Alciatore and M. B. Histan, Introduction to Mechatronics and Measurement Systems, McGraw Hill, 1998.*

Brief Definition for mechatronics

“Mechatronics is the synergistic integration of sensors, actuators, signal conditioning, power electronics, decision and control algorithms, and computer hardware and software to manage complexity, uncertainty, and communication in engineered systems.”

Why Study Mechatronics?

Mechatronics has been popular in Japan and Europe for many years, and has in recent years gained industrial and academic acceptance as a field and study and practice in Great Britain and the United States. The primary role of mechatronics is one of initiation and integration throughout the whole of the design process, with the mechatronics engineer as the leader. Experts in this field must acquire general knowledge of various techniques and be able to master the entire design process. They must be able to use the special knowledge resources of other people and the particular blend of technologies that will provide the most economic, innovative, and appropriate solution to the problem at hand. Industry needs mechatronics engineers to continue to rapidly develop innovative products with performance, quality and low cost in order to compete in today's rapidly changing global environment.

Where are the jobs?

Mechatronic devices or “smart” devices have become common in our technologically advanced society. Mechatronics engineers can work in any company that develops, designs or manufactures and markets “smart” devices. Opportunities exist in manufacturing and sales as well as research. Mechatronic devices can be found in medicine and surgery, agriculture, buildings, homes, automobiles, toys, the entertainment industry, manufacturing, intelligent aids for the elderly and disabled and so much more.

Historical perspective

Advances in microchip and computer technology have bridged the gap between traditional electronic, control and mechanical engineering. Mechatronics responds to industry's increasing demand for engineers who are able to work across the discipline boundaries of electronic, control and mechanical engineering to identify and use the proper combination of technologies for optimum solutions to today's increasingly challenging engineering problems. All around us, we can find mechatronic products.

Mechatronics covers a wide range of application areas including consumer product design, instrumentation, manufacturing methods, motion control systems, computer integration, process and device control, integration of functionality with embedded microprocessor control, and the design of machines, devices and systems possessing a degree of computer-based intelligence. Robotic manipulators, aircraft simulators, electronic traction control systems, adaptive suspensions, landing gears, air-conditioners under fuzzy logic control, automated diagnostic systems, micro electromechanical systems (MEMS), consumer products such as VCRs, and driver-less vehicles are all examples of mechatronic systems.

The genesis of mechatronics is the interdisciplinary area relating to mechanical engineering, electrical and electronic engineering, and computer science. This technology has produced many new products and provided powerful ways of improving the efficiency of the products we use in our daily life. Currently, there is no doubt about the importance of mechatronics as an area in science and technology. However, it seems that mechatronics is not clearly understood; it appears that some people think that mechatronics is an aspect of science and technology which deals with a system that includes mechanisms, electronics, computers, sensors, actuators and so on. It seems that most people define mechatronics by merely considering what component are included in the system and/or how the mechanical functions are realized by computer software. Such a definition gives the impression that it is just a collection of existing aspects of science and technology such as actuators, electronics, mechanisms, control engineering, computer technology, artificial intelligence, and micro-machine and so on, and has no original content as a technology. There are currently several mechatronics textbooks, most of which merely summarize the subject picked up from existing technologies. This structure also gives people the impression that mechatronics has no unique technology. The definition that mechatronics is simply the combination of different technologies is no longer sufficient to explain mechatronics.

Mechatronics solves technological problems using interdisciplinary knowledge consisting of mechanical engineering, electronics, and computer technology. To solve these problems, traditional engineers used knowledge provided only in one of these areas (for example, a mechanical engineer uses some mechanical engineering methodologies to solve the problem at hand). Later, due to the increase in the difficulty of the problems and the advent of more advanced products, researchers and engineers were required to find novel solutions for them in their research and development. This motivated them to search for different knowledge areas and technologies to develop a new product (for example, mechanical engineers tried to introduce electronics to solve mechanical problems). The development of the microprocessor also contributed to encouraging the motivation. Consequently, they could consider the solution to the problems with wider views and more efficient tools; this resulted in obtaining new products based on the integration of interdisciplinary technologies.

Mechatronics gained legitimacy in academic circles with the publication of the first refereed journal: IEEE/ASME Transactions on Mechatronics. In it, the authors worked tenaciously to define mechatronics. Finally they coined the following:

The synergistic combination of precision mechanical engineering, electronic control and systems thinking in the design of products and manufacturing processes.

This definition supports the fact that mechatronics relates to the design of systems, devices and products aimed at achieving an optimal balance between basic mechanical structure and its overall control

Key elements of a mechatronic system

It can be seen from the history of mechatronics that the integration of the different technologies to obtain the best solution to a given technological problem is considered to be the essence of the discipline.

There are at least two dozen definitions of mechatronics in the literature but most of them hinge around the ‘integration of mechanical, electronic, and control engineering, and information technology to obtain the best solution to a given technological problem, which is/ the realization of a product’; we follow this definition. As can be seen, the key element of mechatronics are electronics, digital control, sensors and actuators, and information technology, all integrated in such a way as to produce a real product that is of practical use to people.

The following subsections outline, very briefly, some fundamentals of these key areas. For fuller discussions the reader is invited to explore the rich and established information sources available on mechanics, electrical and electronic theory, instrumentation and control theory, information and computing theory, and numerical techniques.

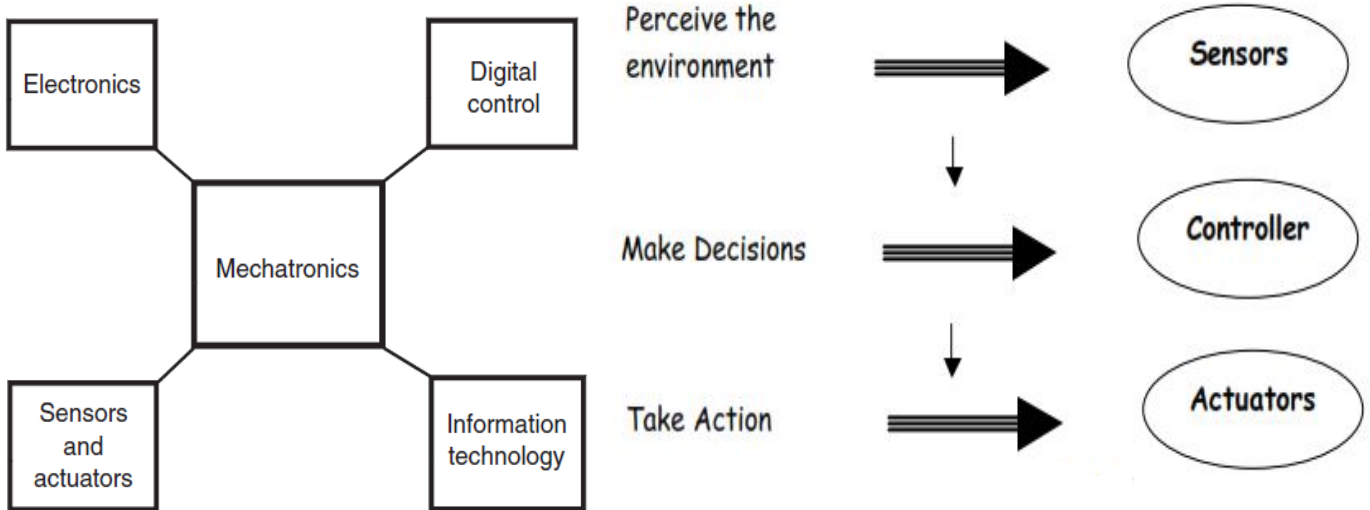

More Examples of Mechatronics

- Robots
- Photocopiers
- Anti-lock brakes
- washers/dryers
- autofocus cameras
- Fuzzy logic based dishwashing machines
- Automated storage and retrieval
- AGV in material handling
- Mine detection robots
- ATMs, cash deposit machines
- Airplanes (auto-pilot)
- Medical devices
- Weapons

Characteristics of Mechatronics

- High speed
- High accuracy
- High Strength
- Reliability
- Miniaturization

Benefits to Industry from mechatronics

- Shorter Development Cycles
- Lower Costs
- Increased Quality
- Increased Reliability
- Increased Performance
- Increased Benefits to customers

Mechatronics to the Future....

- Micro-mechatronics
- Nano-mechatronics
- Opto-mechatronics
- Internet-based mechatronics
- Intelligent/dumb mechatronics
- Entertainment mechatronics
- Educational mechatronics
- Medical mechatronics
- Military mechatronics

Some example of mechatronics

Today, mechatronic systems are commonly found in homes, offices, schools, shops, and of course, in industrial applications. Common mechatronic systems include:

- Domestic appliances, such as fridges and freezers, microwave ovens, washing machines, vacuum cleaners, dishwashers, cookers, timers, mixers, blenders, stereos, televisions, telephones, lawn mowers, digital cameras, videos and CD players, camcorders, and many other similar modern devices;
- Domestic systems, such as air conditioning units, security systems, automatic gate control systems;
- Office equipment, such as laser printers, hard drive positioning systems, liquid crystal displays, tape drives, scanners, photocopiers, fax machines, as well as other computer peripherals;
- Retail equipment, such as automatic labeling systems, bar-coding machines, and tills found in supermarkets;
- Banking systems, such as cash registers, and automatic teller machines;
- Manufacturing equipment, such as numerically controlled (NC) tools, pick-

Mechatronics devices

A computer disk drive is an example of a rotary mechatronic system requires

- Accurate positioning of the magnetic read head
- Precise control of media speed
- Extraction of digital data from magnetic media



Washing Machine System Requirements

Sensors

- Water level, Load speed/balance, Water inlet/drain
- AC or DC Motors

Actuators

- Receptacle to hold clothes
- 'Plumbing' (depth measurement)
- Agitation of drum, Ease of use, Reliability, Low Cost



A photocopier (also known as a copier or copy machine) is a machine that makes paper

Copies of documents and other visual images quickly and cheaply.



Easy example for mechatronics

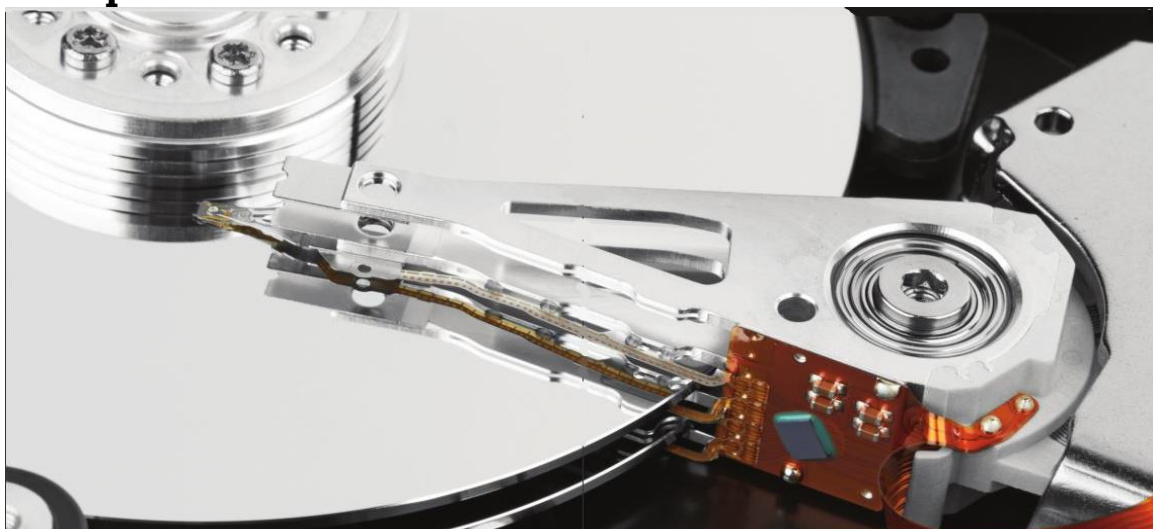

More mechatronics device



a) Robot arm drive



b) photo copier

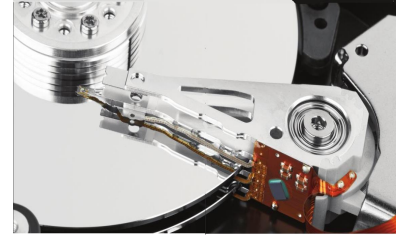

c) hard



d) Digital camera (auto pilot)



e) smart car



f) satellite bomber



g) Drilling tool robot



h) laptop



I) humanoid



j) Washing machine

PART II

ELECTRONICS

Introduction

The word “Electronics” had been derived from the Greek word “Electron” plus “Mechanism”. In its strictest sense, Electronics refers to the discipline that studies the science and technology of motion charges in gas, vacuum and semiconductor. The distinction between information processing and energy processing serves to separate electronics from the rest of electrical engineering. The later deals with devices, circuits and systems used for generation, distribution and conversion of electrical energy. While the former focuses on systems in communication; computation for vast quantities of data manipulation, control and automation of complex manufacturing processes; and components used to realize these.

Brief History of Electronics

It is especially important to study electronic technology because in the last 55 years (the invention of the transistor in 1948) electronics has completely changed communications, information methods, medicine, warfare, and our day-to-day lives. Students should know the basic working principles of the electronics used in radio, television, radar, CD's, lasers, computers, industrial control, power transmissions and other electronic gadgets evolved. Moreover, students must understand how electronics has influenced other sciences such as Microbiology and Genetics. Electronics has even helped improve Social Sciences such as Psychology and Sociology. Many of these improvements in these disciplines can be accredited to the development of the computer microprocessor (still electronics).

Today in the twenty first century, many consumer, military, and recreational products are made with electronic devices. Perhaps, in the future we will see even more uses of electronics as time passes. Almost all phases of modern technological society use electronics, even computers, communication and control systems, home utilities, cars, industries, or the workplace all use electronics. In the modern world almost all of us use Electronic devices use on an increasing bases in every minute of our life. In this section we will briefly review the historical development of Electronics to understand the electronic gadgets use and their wide spread application.



SEMICONDUCTOR

Germanium (Ge) and Silicon (Si) are examples of semiconductor materials that are neither conductors nor insulators. Their electrical conductivity is between that of a conductor and insulator. When isolated germanium and Silicon atoms have four valence electrons (i.e. electrons in the outer orbit).

Semiconductors are divided into two types:

INTRINSIC SEMICONDUCTORS- A semiconductor in the pure form is called intrinsic semiconductor (for example pure silicon and germanium). At room temperature the number of free electrons and holes in an intrinsic semiconductor is insufficient for practical applications.

EXTRINSIC SEMICONDUCTORS- Since intrinsic semiconductors are of little use, impurities have to be added for better results. Doping semiconductors with impurities does this.

N-TYPE SEMICONDUCTOR- By doping Si or Ge with pentavalent impurity for example, Phosphorus, Arsenic or Antimony we get N type semiconductors. By doping with a pentavalent impurity the number of electrons increase and hence there is excess of electrons. These excess electrons contribute to the flow of current.

P-TYPE SEMICONDUCTOR- By adding trivalent impurity for example, Boron, Aluminium, Gallium or Indium to an intrinsic semiconductor, we get p-type semiconductor. This increases the number of holes and therefore these holes contribute to the current.

P N JUNCTION- A P N junction is formed by combining a P-type material and an N-type material together.

A P N junction has the ability to conduct in one direction only .In the reverse direction it offers very high resistance. As soon as a P N junction is formed, the following takes place.

Holes from P region diffuse into the N region and combine with the free holes. This occurs due to thermal energy and difference in concentration .The diffusion of holes and free electrons occurs for a very short time.

The electrons in the P-type region and holes in the N-type region, in the neighborhood of the junction form a barrier.

This is called the depletion region because there is a depletion of mobile charges .An electric field is created at the barrier. The barrier potential is about 0.7V for silicon whereas it is 0.3V for Ge. The barrier does not allow the majority carriers to diffuse any further.

Semiconductor devices

- ✚ Semiconductors are a specific group of elements that exhibit characteristics between those of insulators and conductors.
- ✚ Semiconductor materials typically have four electrons in the outermost valence ring
- ✚ Semiconductors are further characterized as being photoconductive and having a negative temperature coefficient.
- ✚ Photoconductivity: Photons from incident light can increase the carrier density in the material and thereby the charge flow level.
- ✚ Negative temperature coefficient: Resistance will decrease with an increase in temperature (opposite to that of most conductors)

- ✚ resistivity varies from 10^{-5} to 10^{+4} Ohm-meter
- ✚ Germanium (Ge) and Silicon (Si) are example
- ✚ They are rigid, directional and crystalline in nature,
- ✚ Usually, they are bad conductors of electricity. However, some of solids such as Ge and Si can be made to conduct electricity by adding certain impurities in controlled amount, and
- ✚ They have low melting and boiling temperature as compared to ionic solids.

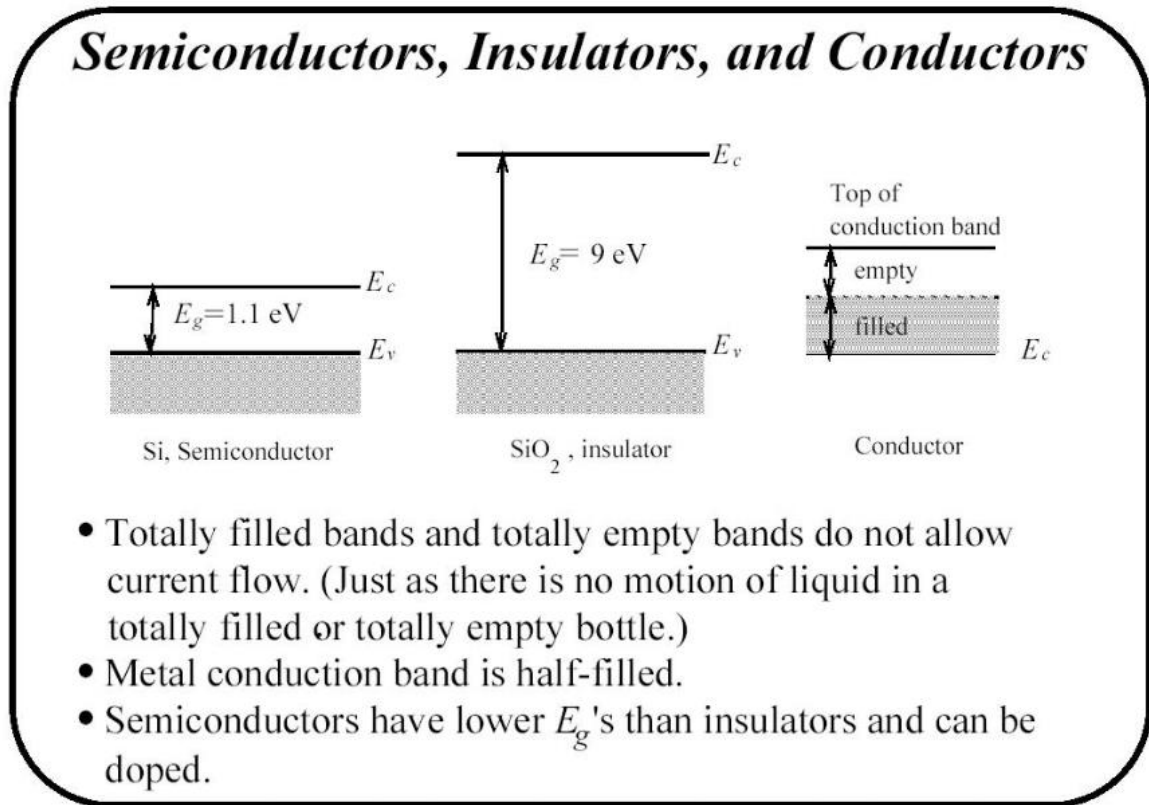

Digital control

In recent years, microprocessors & microcomputer are used in the control system to obtain necessary controlling action. Such controllers use digital signal which exists only at finite instant .in the form of short pulses (digital controllers)

CONTROL SYSTEMS

Introduction

Automatic control is the maintenance of a desired value of quantity or condition by measuring the existing value; compare it with the desired value and employing the difference to initiate action for reducing this difference.

Automatic control systems are used in practically every field of our life. Since, nowadays it has become a tendency to complete the required work or a task automatically by reducing the physical and mental effort. The different applications of automatic control systems are:

1. Domestically they are used in heating and air conditioning.
2. Industrial applications of automatic control system include:
 - Automatic control of machine tool operations.
 - Automatic assembly lines.
 - Quality control, inventory control.
 - In process industries such as food, petroleum, chemical, steel, power etc. for the control of temperature, pressure, flow etc.

- Transportation systems, robotics, power systems also uses automatic control for their operation and control.
- Compressors, pumps, refrigerators.
- Automatic control systems are also used in space technology and defence applications such as nuclear power weapons, guided missiles etc.
- Even the control of social and economic systems may be approached from theory of automatic control.

The term control means to regulate, direct or command. A control system may thus be defined as: "An assemblage of devices and components connected or related so as to command, direct or regulate itself or another system".

In general the objectives of control system are to control or regulate the output in some prescribed manner by the inputs through the elements of the control system.

Basic components of the control system are:

- (1) **Input:** - objectives of control. It is the excitation applied to a control system from external source in order to produce output.
- (2) **Control System Components:** - Devices or components to regulate direct or command a system that the desired objective is achieved.
- (3) **Results or Outputs:** - The actual response obtained from a system.

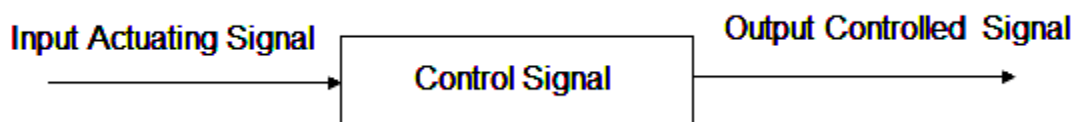

Fig Block diagram of control system.

Classification of Control Systems:

There are two basic types of control Systems:

1. Open Loop System (Non-feed Back)
2. Closed Loop System (Feed Back)

1. Open Loop System (Non-feed Back)

The elements of an open loop system can usually be divided into two parts: the Controller and the Controlled process as shown in Fig

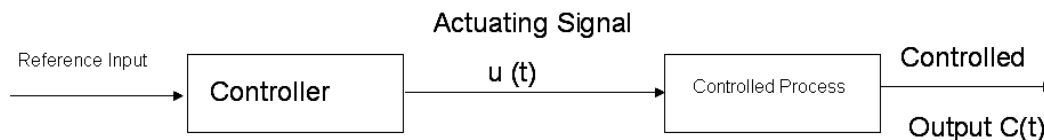

Fig Open loop system

- ✘ An input signal or command $r(t)$ is applied to the controller which generates the actuating signal $u(t)$.
- ✘ Actuating signal $u(t)$ then controls (activates) the process to give controlled output $c(t)$. In simple cases, the controller can be an amplifier, mechanical linkage, filter, or other control element, depending on the nature of the system. In more sophisticated cases the controller can be a computer such as microprocessor.
- ✘ The control action has nothing to do with output $c(t)$ i.e. there is no any relation between input and output.
- ✘ There is no feedback hence it is known as non-feedback system.

Examples of open loop System:

- Traffic control signals at roadway intersections are the open loop systems. The glowing of red and green lamps represents the input. When the red lamp glows the traffic stops. When green lamp glows, it directs the traffic to start.
- The red and green light travels are predetermined by a calibrated timing mechanism and are in no way influenced by the volume of traffic (output).
- Automatic washing machine: In washing machine, input is dirty clothes, water, soap and output is clean cloths. Soaking, washing and rinsing operations are carried out on a time basis. However, the machine does not measure the output signal, namely the cleanliness of the clothes.

Advantages of Open Loop System:

1. Simple in construction.
2. Economic.
3. More stable.
4. Easy maintenance.

Disadvantages of Open Loop System:

1. Inaccurate and unreliable.
2. It is affected by internal and external disturbances; the output may differ from the desired value.
3. It needs frequent and careful calibrations for accurate results.
4. Open loop systems are slow because they are manually controlled.
5. There is no feedback control. The control systems are rather unsophisticated.

2. Closed Loop System

A closed loop control system measures the system output compares it with the input and determines the error, which is then used in controlling the system output to get the desired value.

In closed loop system for more accurate and more adaptive control a link or feedback from the output to the input of the system is provided. The controlled signal $c(t)$ is fed back and compared with the reference input $r(t)$, an actuating signal $e(t)$ proportional to the difference of the input and the output is send through the system to correct the error and bring the system output to the desired value. The system operation is continually correcting any error that may exit. Where $r(t)$ = reference input $e(t)$ = error or actuating signal $b(t)$ = feedback signal m = manipulation

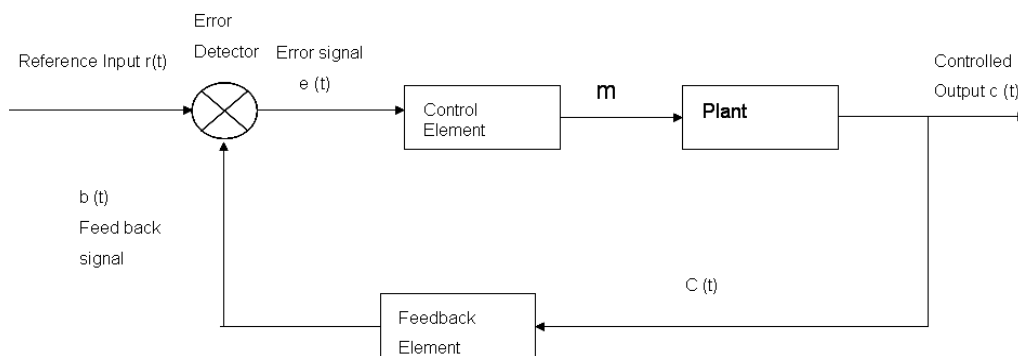

Fig. 30.3 Closed loop system

Advantages of Closed Loop System:

- ✓ These systems can be used in hazardous or remote areas, such as chemical plants, fertilizer plants, areas with high nuclear radiations, and places at very high or very low temperatures.
- ✓ Increased productivity.
- ✓ Relief of human beings from hard physical work and economy in operating cost.
- ✓ Improvement in the quality and quantity of the products.
- ✓ They are more reliable than human operators.

- ✓ A number of variables can be handled simultaneously by closed loop control systems.
- ✓ In such systems there is reduced effect of non-linearity's and distortions.
- ✓ Closed loop systems can be adjusted to optimum control performance.
- ✓ Such system senses environmental changes, as well as internal disturbances and accordingly modifies the error.
- ✓ Satisfactory response over a wide range of input frequencies.

Disadvantages of Closed Loop Control System:

- ✓ It is more complex and expensive.
- ✓ Installation and adjustment is intricate.
- ✓ Maintenance is difficult as it involves complicated electronics. Moreover trained persons are required for maintenance.
- ✓ Due to feedback, system tries to correct the error time to time.
- ✓ Tendency to over correct the error may cause oscillations without bound in the system.
- ✓ It is less stable as compared to open loop system.
- ✓ Table Comparison between open loop and closed loop systems

OPEN LOOP SYSTEM		CLOSED LOOP SYSTEM	
1	No feed back	1	Feedback is present
2	No error detector	2	Error detector is included
3	Simple in construction, easy to built	3	Complex design, difficult to built
4	Disturbances occurring in the process are not controllable	4	Disturbance do not affect the process, they can be controlled automatically
5	It is more stable	5	It is less stable
6	Economical	6	Expensive
7	Less accuracy	7	Accurate
8	Response is slow	8	Response is fast
9	Examples: Two way traffic control, automatic toaster, coffee maker, hand drier	9	Examples: Human being, automatic electric irons, automatic speed control system, centrifugal watt governor etc.

Controllers and control action

An automatic controller compares the actual value of the plant output with the desired value of output, determines the deviation and produces a signal which will reduce the deviation to zero or to a small value.

The manner in which the automatic controller produces the control signal is called control action. The control action may operate through mechanical, pneumatic, hydraulic or electrical means.

Controllers can be in the form of

1. Pneumatic
2. Hydraulic
3. Analogy or digital

The choice of the control action for a particular operation depends upon:

- + The nature of the plant
- + Operating conditions
- + Size and weight
- + Availability and cost
- + Accuracy and reliability and
- + Safety etc.
- + Control Actions

PNEUMATIC CONTROLLER

Pneumatic controllers use air medium (or other gases in special situations) to provide an output signal which is a function of an input error signal. Regulated pressurized air supply at about 20 psg is used as an input signal. Air medium has the advantage of being non-inflammable and having almost negligible viscosity compared to the high viscosity of hydraulic fluids. The danger of explosion existed due to electrical equipment is avoided by pneumatic controller.

Advantages

- The danger of explosion is avoided.
- For operating the final control elements relatively high power amplification is obtained. Due to availability of free supply of air it is relatively inexpensive.
- Comparatively simple and easy to maintain.

Limitations:

- Slow response and longer time delays.
- The lubrication of mating parts creates difficulty.
- Compressed air pipe is necessary throughout the system.
- In pneumatic system there is a considerable amount of compressibility flow so that the systems are characterized by longer time delays

Hydraulic Controllers

In hydraulic controllers power is transmitted through the action of fluid flow under pressure.

The fluid used is relatively incompressible such as petroleum base oils or certain non-inflammable synthetic fluids. Fig. shows schematics of a hydraulic control system.

The major components of a hydraulic controller are:

- + An error detector
- + an amplifier
- + A hydraulic control valve, and
- + An actuator.

Advantages of hydraulic controllers

- + High speed response.
- + High power gain.
- + Long life due to self-lubricating properties of fluid.
- + Simplicity of actuator system
- + Easy maintenance.

Limitations of hydraulic controllers

- + Hydraulic fluids require careful maintenance to remove impurities, corrosive effects etc.
- + Seals should be properly maintained to prevent leakage of hydraulic fluids.

Electric controllers

Electrical control devices are most widely used because of their accuracy and fast response with easy handling techniques. Electric controller for proportional, proportional plus integral and proportional + integral + derivative actions may be divided into two types:

1. The null balance type in which an electrical feedback signal is given to the controller from the final elements
2. The direct type in which there is no such feedback signal.

As with the pneumatic controller, the various control actions are accomplished by modifying the feedback signal. This is done by adding properly combined electrical resistances and capacitances to feedback circuit just as restrictions and bellows were added in the pneumatic circuit.

A very simple form of two step controller is the room-temperature thermostat. The U shaped bimetal strip fixed at one end of the thermostat frame deflects when heated, its free end moving in such a direction as to separate the fixed and moving contacts. When the bimetal strip cools the two contacts are once more brought in contact. The small permanent magnet ensures the opening and closing of the contacts with a snap action to minimize the damage caused by arcing. The adjusting screw varies the small range of temperature, sometimes called the differential gap between contacts opening on rising temperature and closing on falling temperature.

Part III

TRANSDUCER

A transducer is a device that converts a signal in one form of energy to another form of energy.^[1] Energy types include (but are not limited to) electrical, mechanical, electromagnetic (including light), chemical, acoustic and thermal energy. While the term transducer commonly implies the use of a sensor/detector, any device which converts energy can be considered a transducer. Transducers are widely used in measuring instruments.

Transducers convert one form of energy into another

Sensors/Actuators are input/output transducers

Sensors can be passive (e.g. change in resistance) or active (output is a voltage or current level)

Sensors can be analog (e.g. thermocouples) or digital (e.g. digital tachometer)

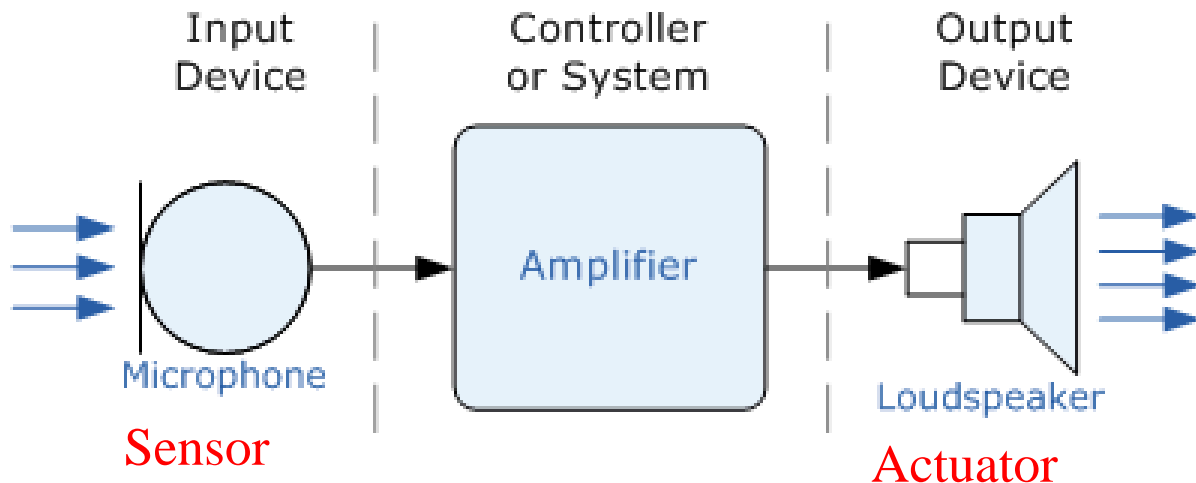

CHARACTERISTICS OF TRANSDUCERS

1. Ruggedness
2. Linearity
3. Repeatability
4. Accuracy
5. High stability and reliability
6. Speed of response
7. Sensitivity
8. Small size

TRANSDUCERS SELECTION FACTORS

- **Operating Principle:** The transducer are many times selected on the basis of operating principle used by them. The operating principle used may be resistive, inductive, capacitive, optoelectronic, piezo electric etc.
- **Sensitivity:** The transducer must be sensitive enough to produce detectable output.
- **Operating Range:** The transducer should maintain the range requirement and have a good resolution over the entire range.

- Accuracy: High accuracy is assured.
- Cross sensitivity: It has to be taken into account when measuring mechanical quantities. There are situation where the actual quantity is being measured is in one plane and the transducer is subjected to variation in another plan.
- Errors: The transducer should maintain the expected input-output relationship as described by the transfer function so as to avoid errors.

The transducers can be classified as:

- Active and passive transducers.
- Analog and digital transducers.
- On the basis of transduction principle used.
- Primary and secondary transducer
- Transducers and inverse transducers.

Sensors and their application

Sensors

A **sensor** is a converter that measures a physical quantity and converts it into a signal which can be read by an observer or by an (today mostly electronic) instrument. For example, a mercury-in-glass thermometer converts the measured temperature into expansion and contraction of a liquid which can be read on a calibrated glass tube. A thermocouple converts temperature to an output voltage which can be read by a voltmeter. For accuracy, most sensors are calibrated against known standards.

A good sensor obeys the following rules:

- Is sensitive to the measured property only
- Is insensitive to any other property likely to be encountered in its application
- Does not influence the measured property



Sound
(Pressure)



Touch



Light
(Light intensity)



Ultrasonic
(Distance)

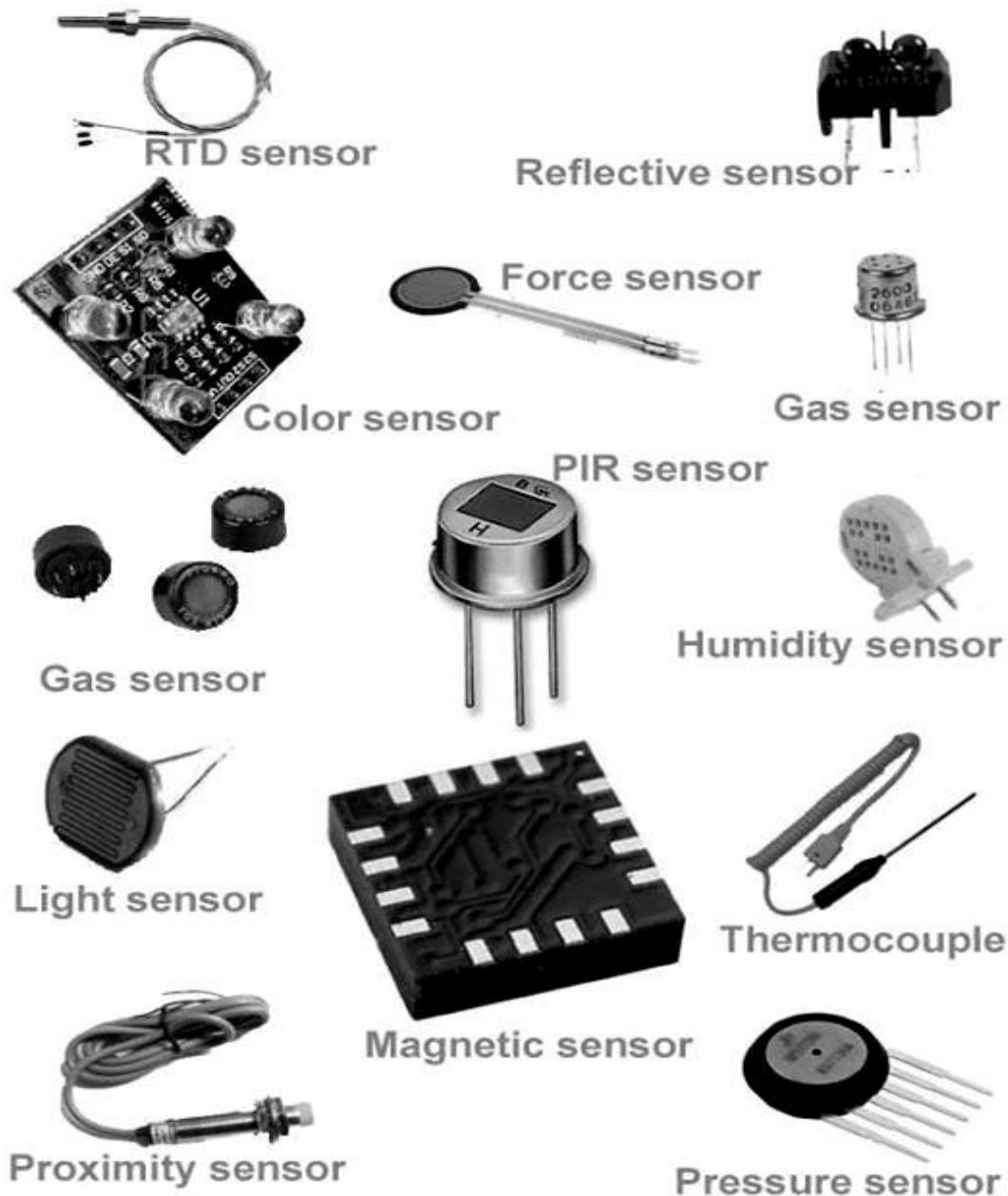

All living organisms contain biological sensors with functions similar to those of the mechanical devices described. Most of these are specialized cells that are sensitive to:

- Light, motion, temperature, magnetic fields, gravity, humidity, moisture, vibration, pressure, electrical fields, sound, and other physical aspects of the external environment
- Physical aspects of the internal environment, such as stretch,
- motion of the organism, and position of appendages (proprioception)
- Environmental molecules, including toxins, nutrients, and pheromones
- Estimation of biomolecules interaction and some kinetics parameters
- Internal metabolic indicators, such as glucose level, oxygen level, or osmolality
- Internal signal molecules, such as hormones, neurotransmitters, and cytokines
- Differences between proteins of the organism itself and of the environment or alien creatures.

ACTUATORS

An actuator is the device that brings about the mechanical movements required for any physical process in the factory. Internally, actuators can be broken down into two separate modules: the *signal amplifier* and the *transducer*. The amplifier converts the (low power) control signal into a high power signal that is fed into the transducer; the transducer converts the energy of the amplified control signal into work; this process usually involves converting from one form of energy into another, e.g. electrical motors convert electrical energy into kinetic energy.

It is operated by a source of energy, typically electric current, hydraulic fluid pressure, or pneumatic pressure, and converts that energy into motion. An actuator is the mechanism by which a control system acts upon an environment. The control system can be simple (a fixed mechanical or electronic system), software-based (e.g. a printer driver, robot control system), a human, or any other input.

Types of Actuators

1. Electrical

- Ac and dc motors
- Stepper motors
- solenoids

2. Hydraulic

- Use hydraulic fluid to actuate motion

3. Pneumatic

- Use compressed air to actuate motion

All three types of actuators are in use today. Electric actuators are the type most commonly used Hydraulic and pneumatic systems allow for increased force and torque from smaller motor

Actuator characteristics:

Three major characteristics of actuators are accuracy, precision, and reliability. The definitions of these parameters are consistent with the corresponding definitions given earlier for sensors.

Motors

All electric motors use electromagnetic induction to generate a force on a rotational element called the rotor. The torque required to rotate the rotor is created due to the interaction of magnetic fields generated by the rotor, and the part surrounding it, which is fixed, and called the stator.

Motor type	Speed	Starting	Applications
DC series	very high	very high	Hoists, Gates, Trams, Trains,
DC shunt	low	medium	Printing press, Machine tools,
DC	medium	high	Punch press, Shears, Crushers

Motor Controls:

Many motor applications are not sensitive enough to require very tight accuracy of speed or control over the motion. However, from the viewpoint of manufacturing and production automation, such considerations are critical. For instance, any robot actuator requires that its motion be governable in positioning, velocity and acceleration with very high accuracy. Similarly, most NC machines have all their actuators controlled to provide positioning accuracy that is one order of magnitude less than the required accuracy of the part being manufactured. Considering that the typical tolerance on steel parts is 0.001 inch or less, this means that the machine controller has to be able to move the machine table to less than one-thousandths of an inch of the programmed point. How are such precise motions generated?

The two most common motor types used in such applications are **stepper motors**, and **servo-driven motors** (or simply, servomotors).

Stepper Motors

Stepper motors rotate in discrete steps (e.g. 2° for each step); they have many uses, especially in motion for robots and locating or indexing tables. Their working principle is similar to DC motors, but they are controlled by digital electronics: an electronic circuit turns a series of switches ON and OFF at each electrical pulse input to the stepper motor control. The stepper motor is driven by feeding it a stream of electric pulses. Each pulse makes the motor rotate by a fixed angle.

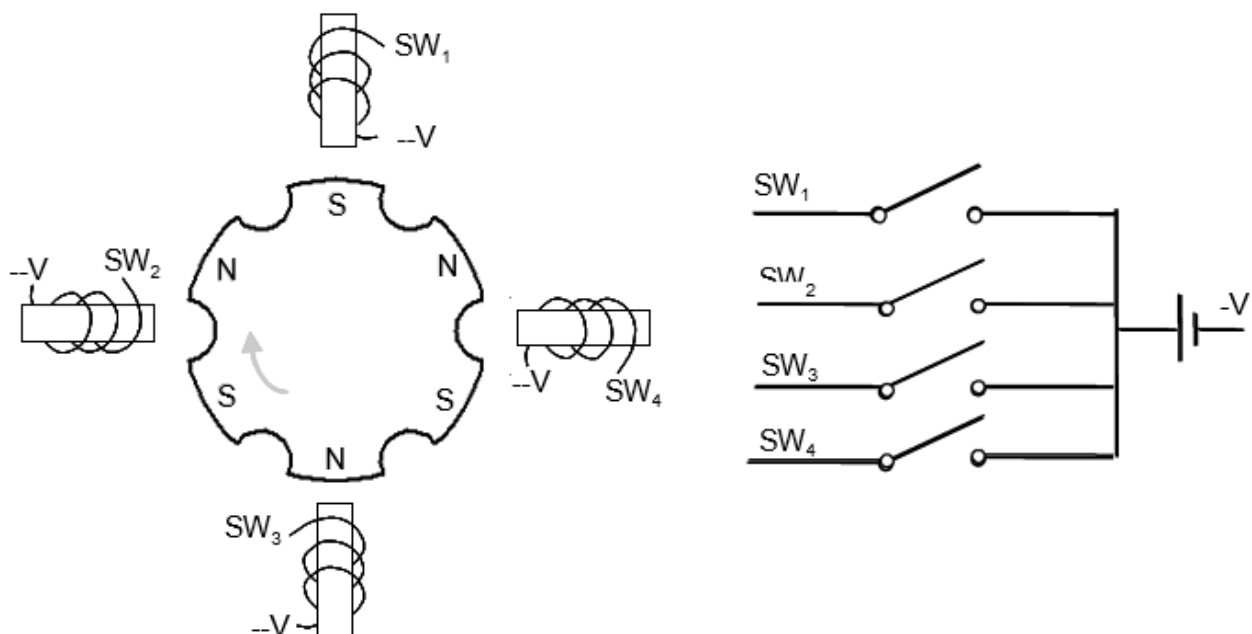

Full Steps (CW)

Degs	SW ₁	SW ₂	SW ₃	SW ₄
0	ON			
30		ON		
60			ON	
90				ON
120	ON			
150		ON		

Degs	SW ₁	SW ₂	SW ₃	SW ₄
0	ON			
15	ON	ON		
30		ON		
45		ON	ON	
60			ON	
75			ON	ON
90				ON

Figure 3.5. The principle of the Stepper Motor

✚ Stepper motors can only provide low torques. They are commonly used in laser positioning, pen positioning, disc and CDROM drives, robots, positioning tables etc.

Servo Motors

When higher torque *and* precise control are needed, servo motors are the best option. They provide high torque at all speeds, versatile speed control, very low drift (and therefore high repeatability), ability to reverse directions rapidly and smoothly etc. Servomotors may be AC or DC. In fact, practically any AC or DC motor can be converted to a servomotor by regulating it electronically, and using position and force feedbacks. Since the servomotors are driven through this electronic control, they are also easily interfaced with microprocessors or other high level controlling devices quite easily. The digital signal from the computer is converted to its equivalent analog level via an electronic DA converter.

Hydraulic Actuators

Hydraulic systems are often used for driving high-power machine tools and industrial robots. They can deliver high power and forces. They also suffer from maintenance problems (e.g. leakage of the hydraulic fluid, dirt/contamination of fluid.) Hydraulic actuators may be linear, or rotary.

Pneumatic actuators

Pneumatic actuators work, in principle, similar to hydraulic actuators. The most common pneumatic controls are linear actuators, which are basically a piston-cylinder assembly connected to a supply tube of compressed air. Since air is highly compressible, pneumatic drives are frequently not used for high force transmission, nor are much good for accurate position control. Typically, they are used for fixed motion of small objects that are very common on assembly and transfer lines.

Electro-mechanical element

Micro-electro-mechanical systems (i.e. MEMS) are integrated systems of microelectronics (IC), micro actuator and, in most cases, micro sensors. MEMS technology offers unique advantages

Including miniaturization, mass fabrication and monolithic integration with microelectronics, and makes it possible to fabricate small devices and systems with high functionality, precision and performance. More important, MEMS technology can enable new circuit components and new functions. Therefore, MEMS have attracted considerable attention since 1987.

Micro actuators are the key part of MEMS. For many MEMS devices such as switches, optical attenuators, pumps, valves, etc., micro actuators are required to

realize their physical functions. The controlled actuation or motion of micro actuators can be achieved by several kinds of actuation mechanisms. Electrostatic, piezoelectric, magnetostrictive, magnetic, thermo mechanical actuators have been reported.

Among the different actuation principles, the electrostatic actuation is predominantly employed for the electrostatic micro actuators' characteristics of simple structures, small energy loss and being compatible with integrated circuit processes. However, electrostatic actuation mechanism has the disadvantages of high driving voltage and small displacement; the high driving voltage has an adverse effect on the lifetime of devices.